

IS31LT3170/71

10-TO-150MA CONSTANT-CURRENT LED DRIVER

October 2017

GENERAL DESCRIPTION

The IS31LT3170 and IS31LT3171 are adjustable linear current devices with excellent temperature stability. A single resistor is all that is required to set the operating current from 10mA to 150mA. The devices can operate from an input voltage from 2.5V to 42V with a minimal voltage headroom of 1V (typical). Designed with a low dropout voltage; the device can drive LED strings close to the supply voltage without switch capacitors or inductors.

The IS31LT3170/71 simplifies designs by providing a stable current without the additional requirement of input or output capacitors, inductors, FETs or diodes. The complete constant current driver requires only a current set resistor and a small PCB area making designs both efficient and cost effective.

The EN pin (1) of the IS31LT3170 can be tied to Vbat or BCM PWM signal for high side dimming. The EN Pin (1) of the IS31LT3171 can function as the PWM signal input used for low side dimming.

As a current sink it is ideal for LED lighting applications or current limiter for power supplies.

The device is provided in a lead (Pb) free, SOT23-6 package.

FEATURES

- Low-side current sink
 - Current preset to 10mA
 - Adjustable from 10mA to 150mA with external resistor selection
- Wide input voltage range from
 - 2.5V to 42V (IS31LT3171)
 - 5V to 42V (IS31LT3170)
 with a low dropout of typical 1V
- Up to 10kHz PWM input (IS31LT3171 only)
- Protection features:
 - 0.26%/K negative temperature coefficient at high temp for thermal protection
- Up to 1W power dissipation in a small SOT23-6 package
- RoHS compliant (Pb-free) package

APPLICATIONS

- Architectural LED lighting
- Channel letters for advertising, LED strips for decorative lighting
- Retail lighting in fridge, freezer case and vending machines
- Emergency lighting (e.g. steps lighting, exit way sign etc.)

TYPICAL APPLICATION CIRCUIT

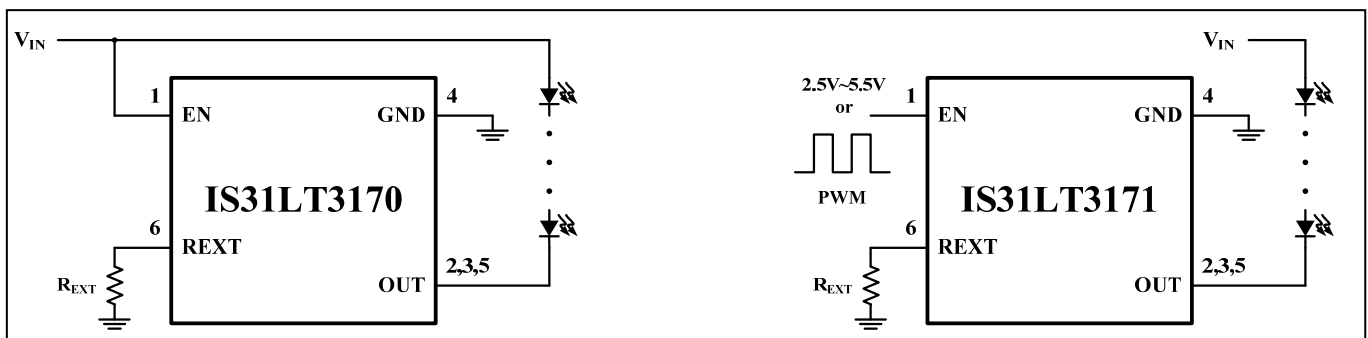
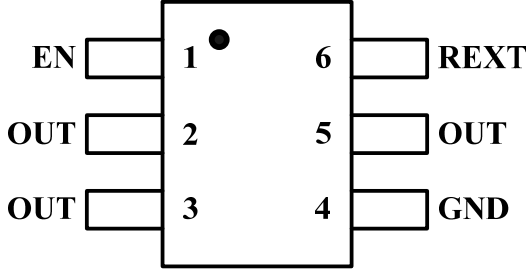

Figure 1 Typical Application Circuit

IS31LT3170/71

PIN CONFIGURATION

Package	Pin Configuration (Top View)
SOT23-6	

PIN DESCRIPTION

No.	Pin	Description
1	EN	Enable pin (PWM input IS31LT3171 only).
2,3,5	OUT	Current sink.
4	GND	Ground.
6	REXT	Optional current adjust.



IS31LT3170/71

ORDERING INFORMATION

Industrial Range: -40°C to +125°C

Order Part No.	Package	QTY/Reel
IS31LT3170-STLS4-TR IS31LT3171-STLS4-TR	SOT-23-6, Lead-free	3000

Copyright © 2017 Integrated Silicon Solution, Inc. All rights reserved. ISSI reserves the right to make changes to this specification and its products at any time without notice. ISSI assumes no liability arising out of the application or use of any information, products or services described herein. Customers are advised to obtain the latest version of this device specification before relying on any published information and before placing orders for products. Integrated Silicon Solution, Inc. does not recommend the use of any of its products in life support applications where the failure or malfunction of the product can reasonably be expected to cause failure of the life support system or to significantly affect its safety or effectiveness. Products are not authorized for use in such applications unless Integrated Silicon Solution, Inc. receives written assurance to its satisfaction, that:

- a.) the risk of injury or damage has been minimized;
- b.) the user assume all such risks; and
- c.) potential liability of Integrated Silicon Solution, Inc is adequately protected under the circumstances

IS31LT3170/71

ABSOLUTE MAXIMUM RATINGS (Note 1)

Maximum enable voltage, $V_{EN(MAX)}$ only for IS31LT3170-STLS4-TR $V_{EN(MAX)}$ only for IS31LT3171-STLS4-TR	45V 6V
Maximum output current, $I_{OUT(MAX)}$	200mA
Maximum output voltage, $V_{OUT(MAX)}$	45V
Reverse voltage between all terminals, V_R	0.5V
Package thermal resistance, junction to ambient (4 layer standard test PCB based on JEDEC standard), θ_{JA}	130°C/W
Power dissipation, $P_{D(MAX)}$ (Note 2)	0.77W
Maximum junction temperature, T_{JMAX}	+150°C
Storage temperature range, T_{STG}	-65°C ~ +150°C
Operating temperature range, $T_A=T_J$	-40°C ~ +125°C
ESD (HBM)	±2kV
ESD (CDM)	±500V

Note 1:

Stresses beyond those listed under “Absolute Maximum Ratings” may cause permanent damage to the device. These are stress ratings only and functional operation of the device at these or any other condition beyond those indicated in the operational sections of the specifications is not implied. Exposure to absolute maximum rating conditions for extended periods may affect device reliability.

Note 2:

Detail information please refer to package thermal de-rating curve on Page 14.

ELECTRICAL CHARACTERISTICS

“●” This symbol in the table means these parameters are for IS31LT3170-STLS4-TR.

“○” This symbol in the table means these parameters are for IS31LT3171-STLS4-TR.

Test condition is $T_A = T_J = 25^\circ\text{C}$, unless otherwise specified. (Note 3)

Symbol	Parameter	Condition	Min.	Typ.	Max.	Unit
V_{BD_OUT}	OUT pin breakdown voltage	$V_{EN} = 0V$	42			V
I_{EN}	Enable current	$V_{EN} = 24V$ ●		0.35		mA
		$V_{EN} = 3.3V$ ○		0.35		
R_{INT}	Internal resistor	$I_{RINT} = 10mA$		106		Ω
I_{OUT}	Output current	$V_{OUT} = 1.4V, V_{EN} = 24V, R_{EXT} \text{ OPEN}$ ●	9	10	11	mA
		$V_{OUT} = 1.4V, V_{EN} = 3.3V, R_{EXT} \text{ OPEN}$ ○	9	10	11	
		$V_{OUT} > 2.0V, V_{EN} = 24V, R_{EXT} = 10\Omega$ ●	100	113	120	mA
		$V_{OUT} > 2.0V, V_{EN} = 3.3V, R_{EXT} = 10\Omega$ ○	100	113	120	
	Output current Range (Note 4, 5)	$V_{OUT} > 2.0V, V_{EN} = 24V$ ●	10		150	mA
		$V_{OUT} > 2.0V, V_{EN} = 3.3V$ ○	10		150	

IS31LT3170/71

DC CHARACTERISTICS WITH STABILIZED LED LOAD

“●” This symbol in the table means these parameters are for IS31LT3170-STLS4-TR.

“○” This symbol in the table means these parameters are for IS31LT3171-STLS4-TR.

Test condition is $T_A = T_J = 25^\circ\text{C}$, unless otherwise specified. (Note 3)

Symbol	Parameter	Condition		Min.	Typ.	Max.	Unit
V_S	Sufficient supply voltage on EN pin		●	5		42	V
			○	2.5		5.5	
V_{HR}	Lowest sufficient headroom voltage on OUT pin	$I_{OUT} = 100\text{mA}$			1	1.2	V
$\Delta I_{OUT}/I_{OUT}$ (Note 4)	Output current change versus ambient temp change	$V_{OUT} > 2.0\text{V}, V_{EN} = 24\text{V}, R_{EXT} = 10\Omega$	●		-0.26		%K
			○		-0.26		
	Output current change versus V_{out}	$V_{OUT} > 2.0\text{V}, V_{EN} = 24\text{V}, R_{EXT} = 10\Omega$	●		1.9		%V
			○		1.9		

Note 3: Production testing of the device is performed at 25°C . Functional operation of the device and parameters specified over -40°C to $+125^\circ\text{C}$ temperature range, are guaranteed by design and characterization.

Note 4: Guaranteed by design.

Note 5: The maximum output current is dependent on the PCB board design, air flow, ambient temperature and power dissipation in the device. Please refer to the package thermal de-rating curve on Page 14 for more detail information.

IS31LT3170/71

FUNCTIONAL BLOCK DIAGRAM

IS31LT3170

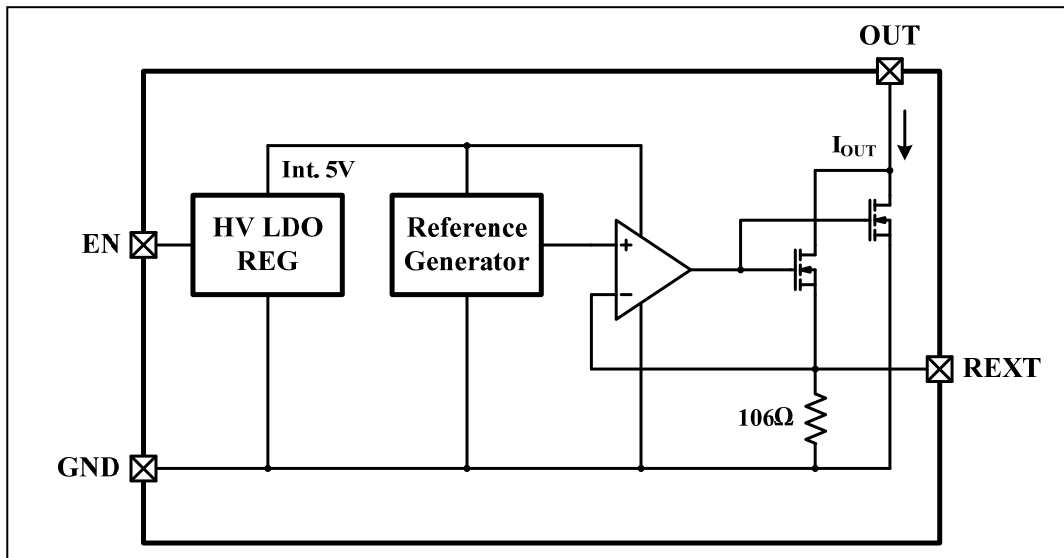

IS31LT3171

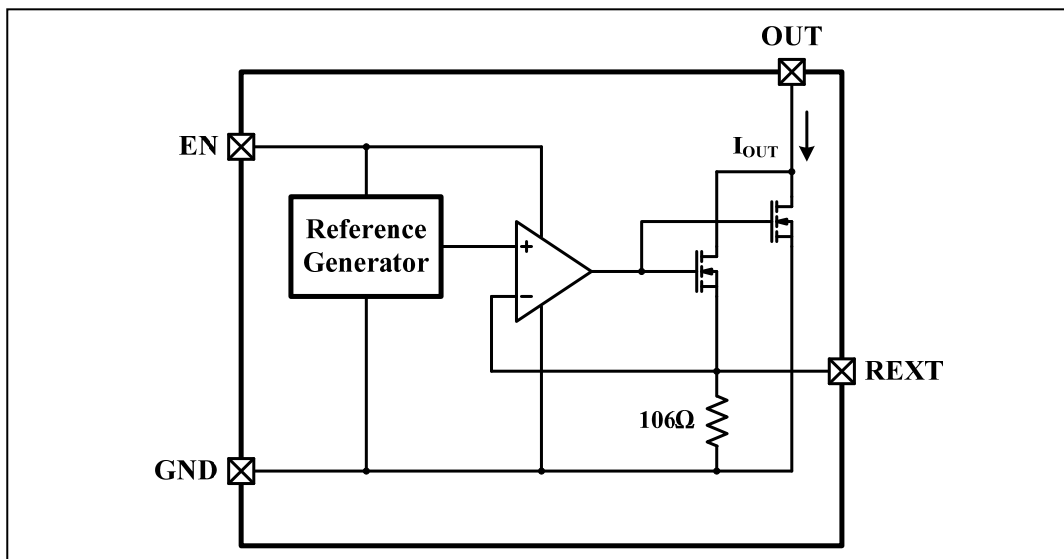

IS31LT3170/71

TYPICAL PERFORMANCE CHARACTERISTICS

IS31LT3170

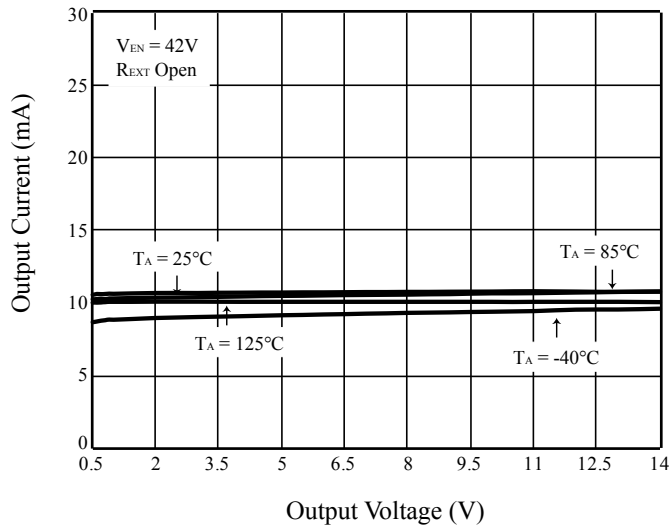

Figure 2 I_{OUT} vs. V_{OUT}

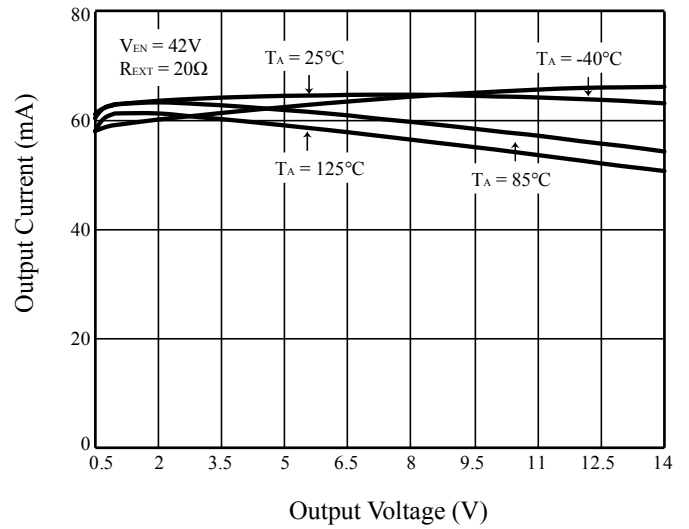

Figure 3 I_{OUT} vs. V_{OUT}

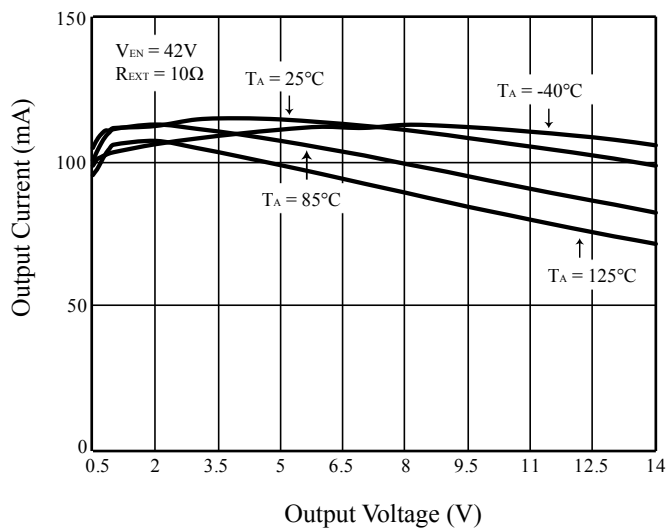

Figure 4 I_{OUT} vs. V_{OUT}

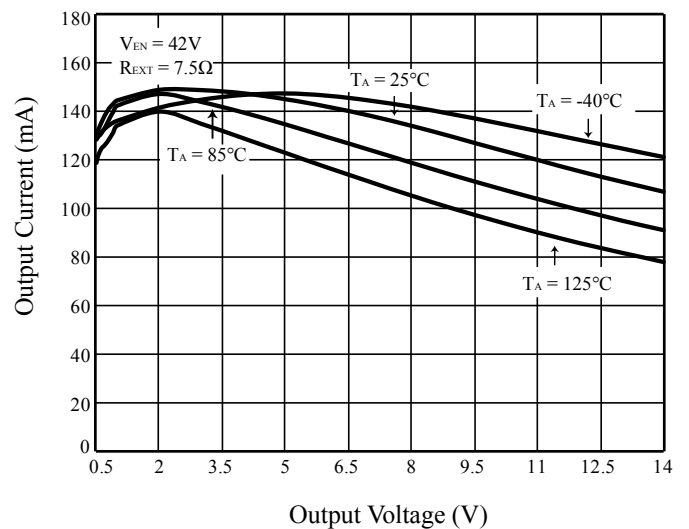

Figure 5 I_{OUT} vs. V_{OUT}

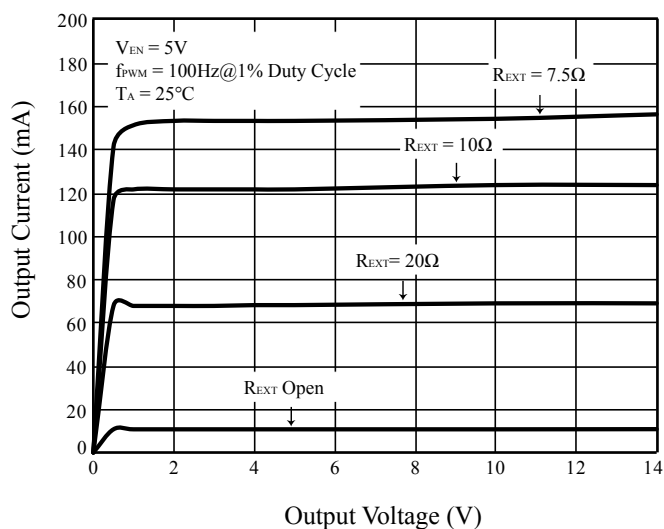

Figure 6 I_{OUT} vs. V_{OUT}

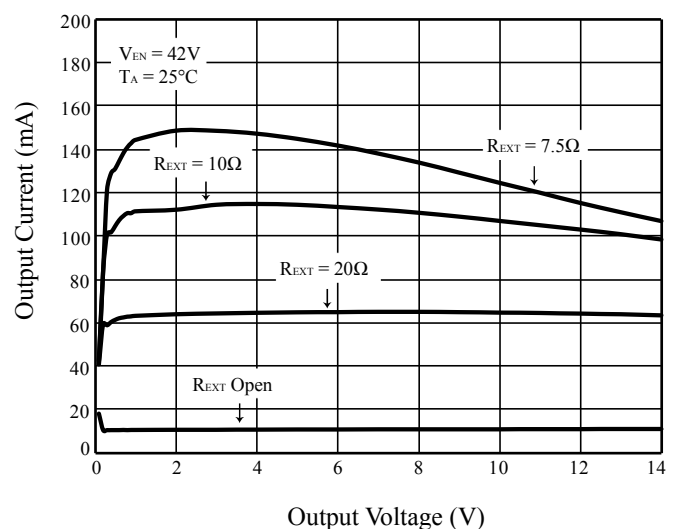

Figure 7 I_{OUT} vs. V_{OUT}

IS31LT3170/71

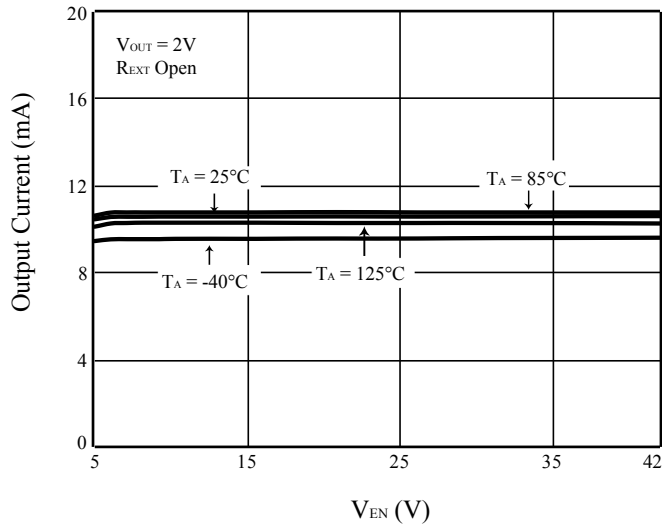

Figure 8 I_{OUT} vs. V_{EN}

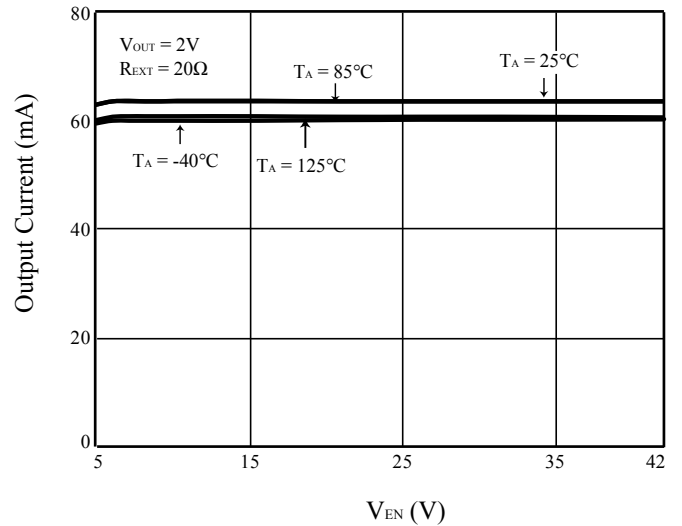

Figure 9 I_{OUT} vs. V_{EN}

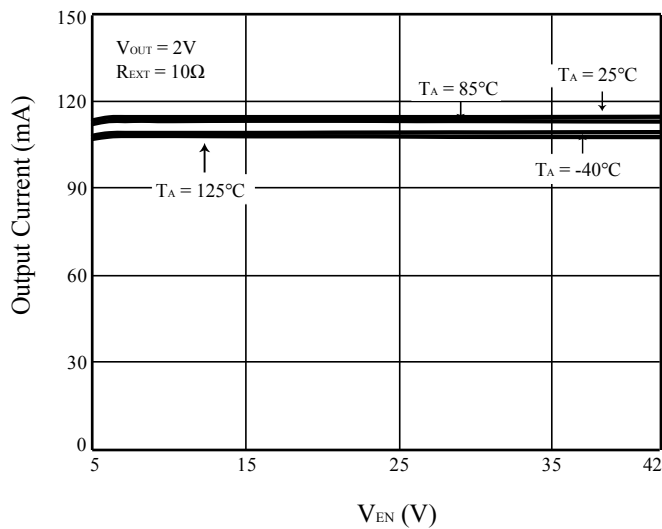

Figure 10 I_{OUT} vs. V_{EN}

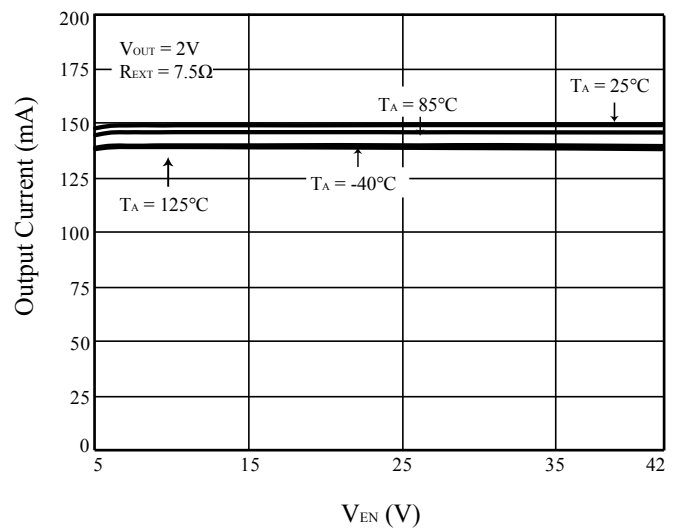

Figure 11 I_{OUT} vs. V_{EN}

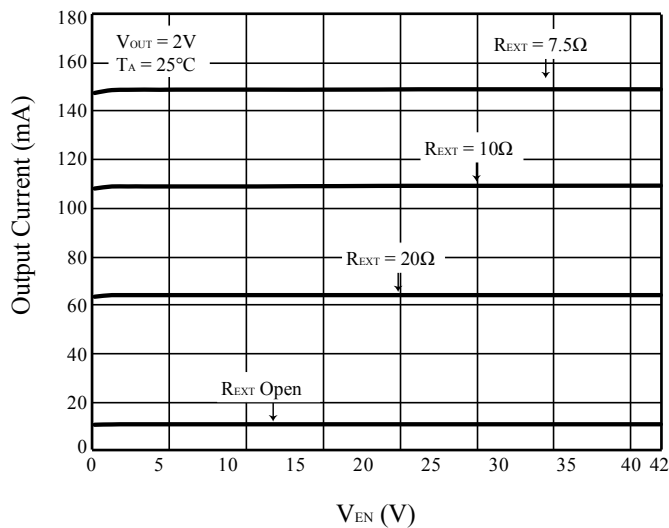

Figure 12 I_{OUT} vs. V_{EN}

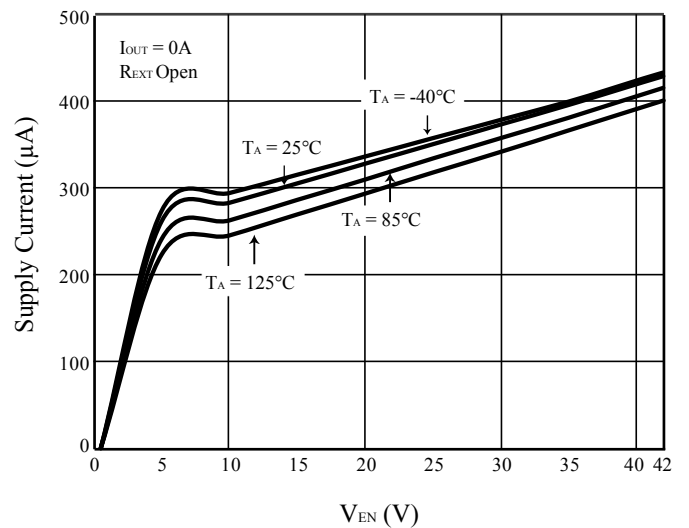

Figure 13 I_{EN} vs. V_{EN}

IS31LT3170/71

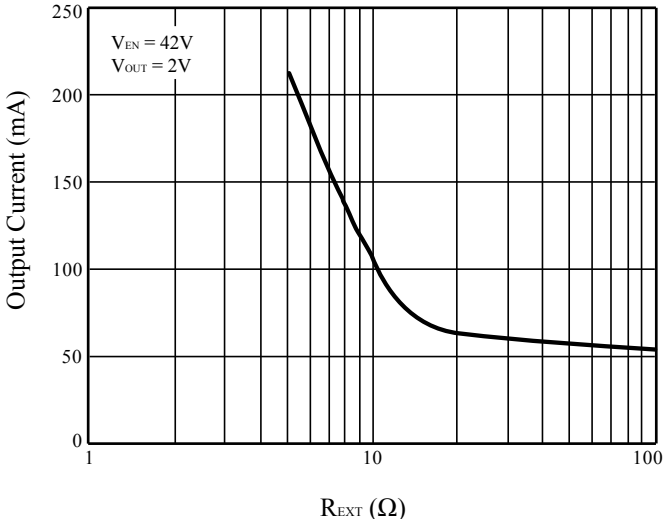

Figure 14 I_{OUT} vs. R_{EXT}

IS31LT3170/71

IS31LT3171

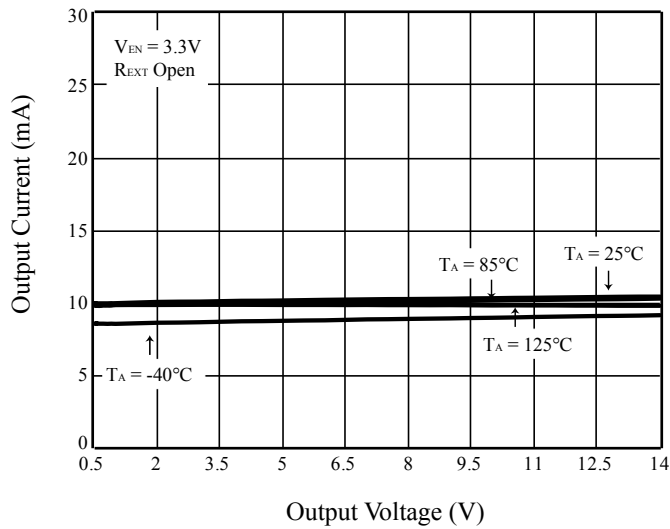

Figure 15 I_{OUT} vs. V_{OUT}

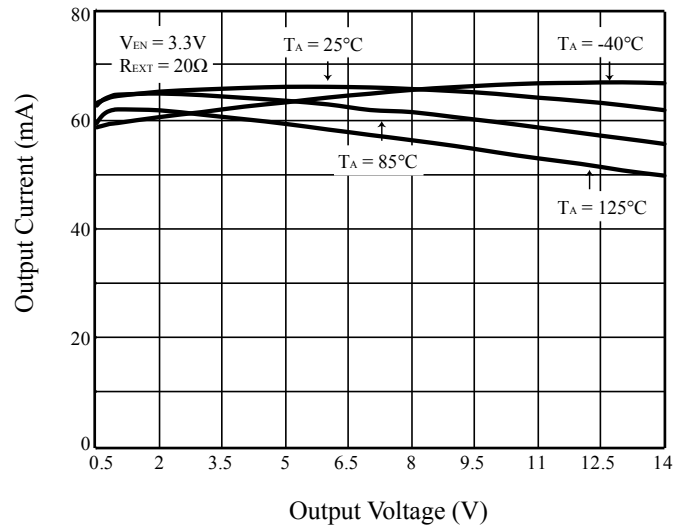

Figure 16 I_{OUT} vs. V_{OUT}

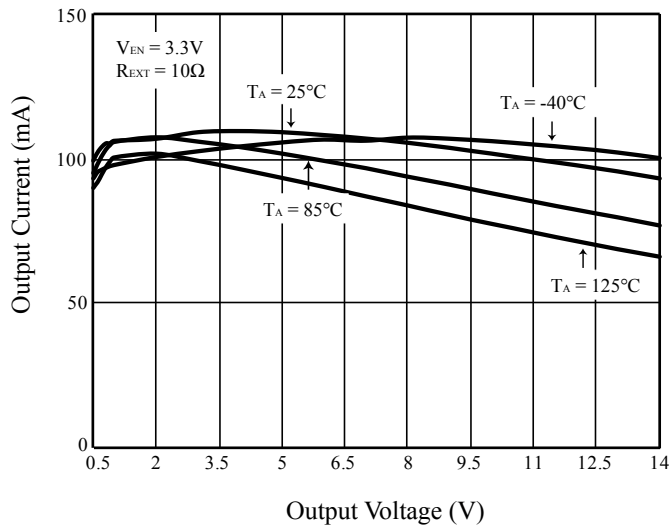

Figure 17 I_{OUT} vs. V_{OUT}

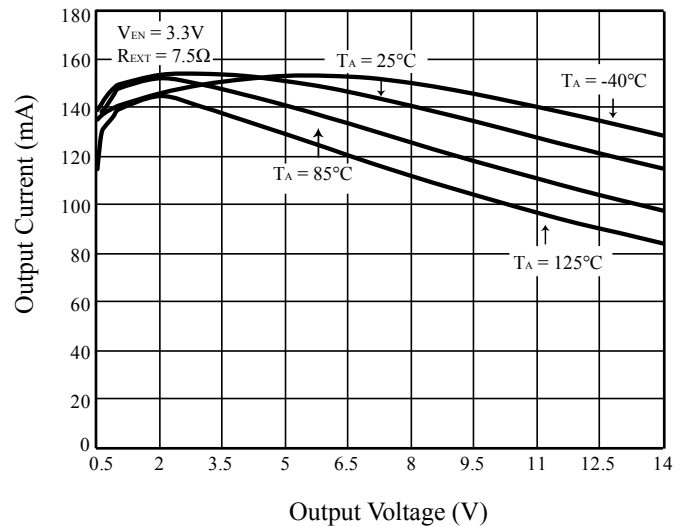

Figure 18 I_{OUT} vs. V_{OUT}

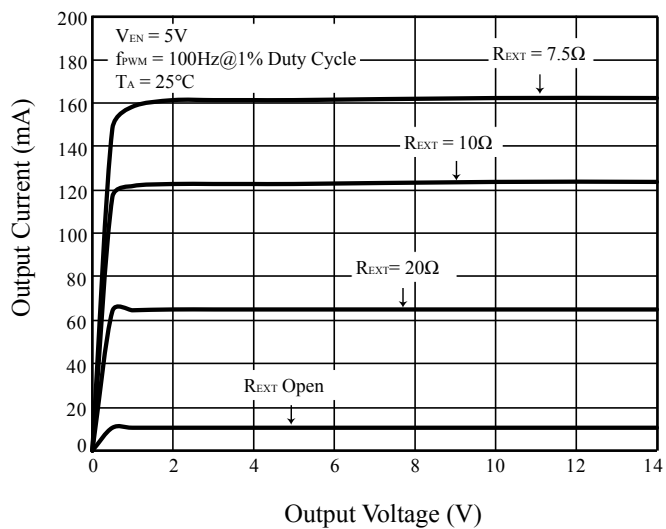

Figure 19 I_{OUT} vs. V_{OUT}

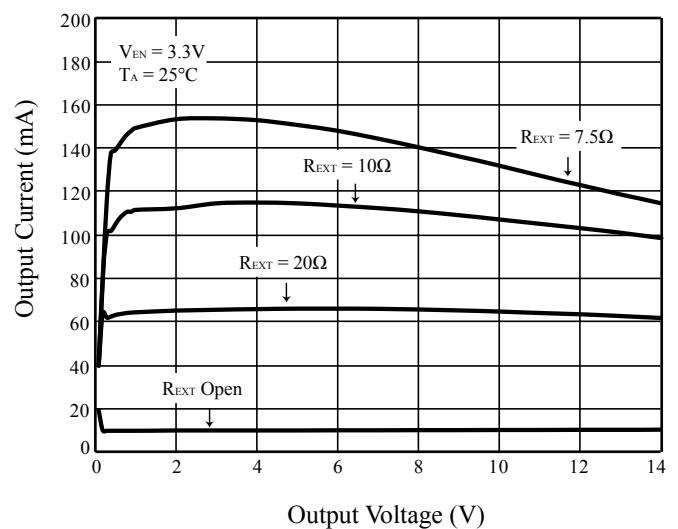

Figure 20 I_{OUT} vs. V_{OUT}

IS31LT3170/71

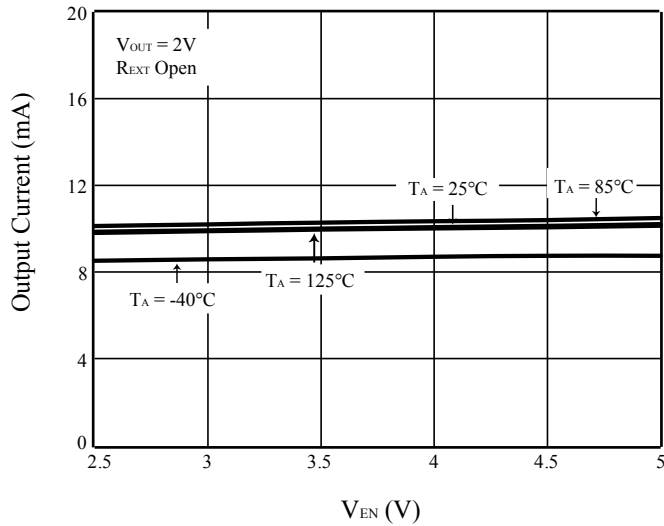

Figure 21 I_{OUT} vs. V_{EN}

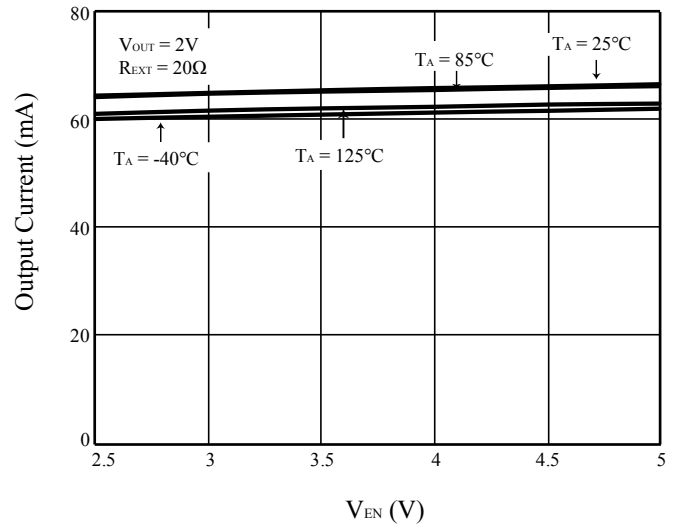

Figure 22 I_{OUT} vs. V_{EN}

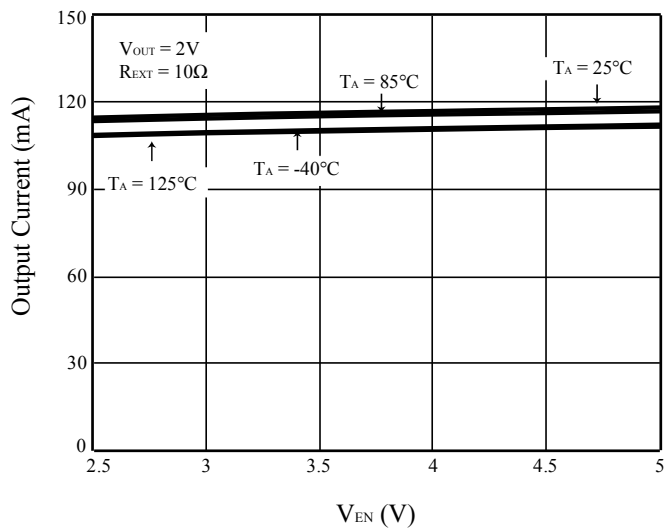

Figure 23 I_{OUT} vs. V_{EN}

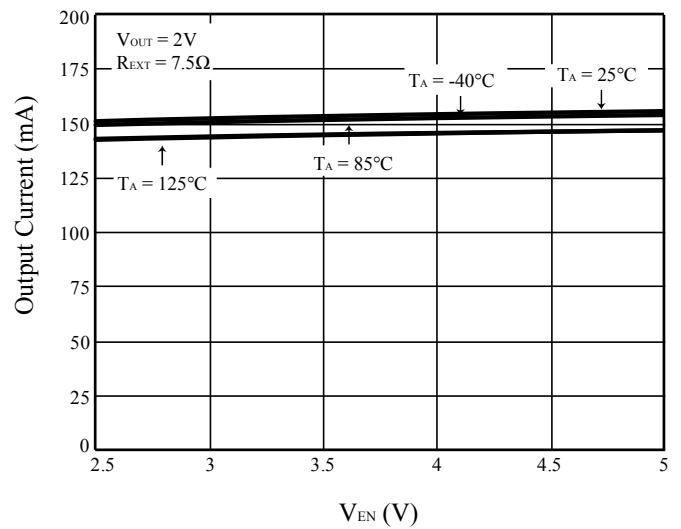

Figure 24 I_{OUT} vs. V_{EN}

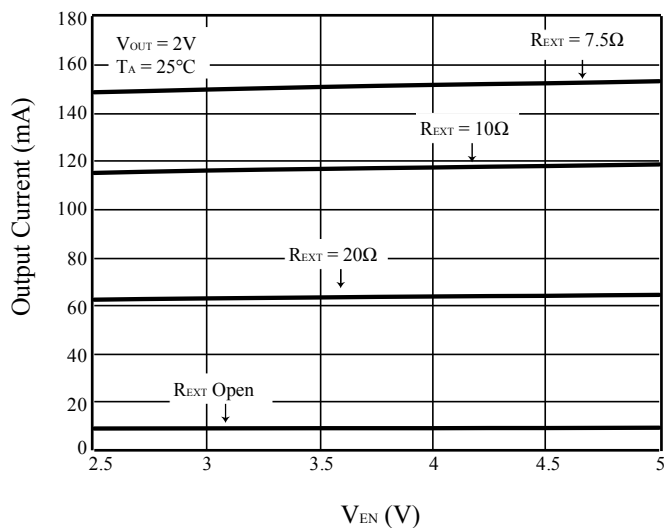

Figure 25 I_{OUT} vs. V_{EN}

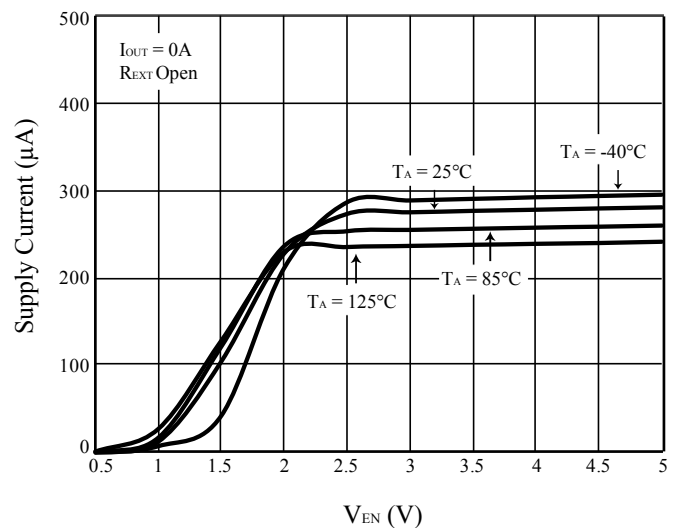

Figure 26 I_{EN} vs. V_{EN}

IS31LT3170/71

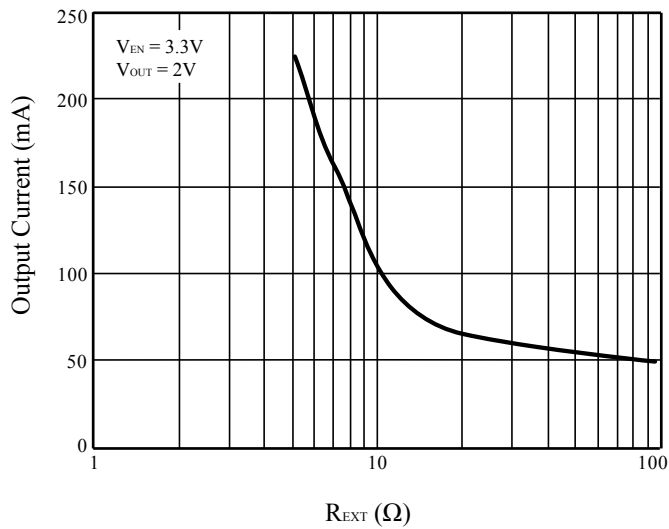

Figure 27 I_{OUT} vs. R_{EXT}

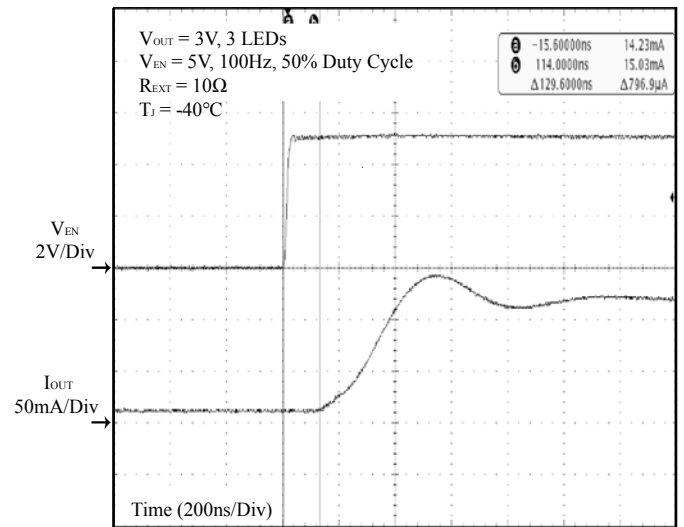

Figure 28 V_{EN} vs. I_{OUT} Delay and Rising Edge

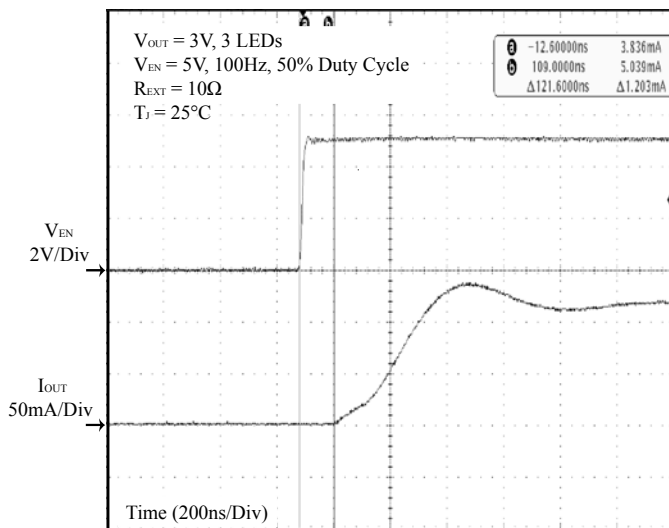

Figure 29 V_{EN} vs. I_{OUT} Delay and Rising Edge

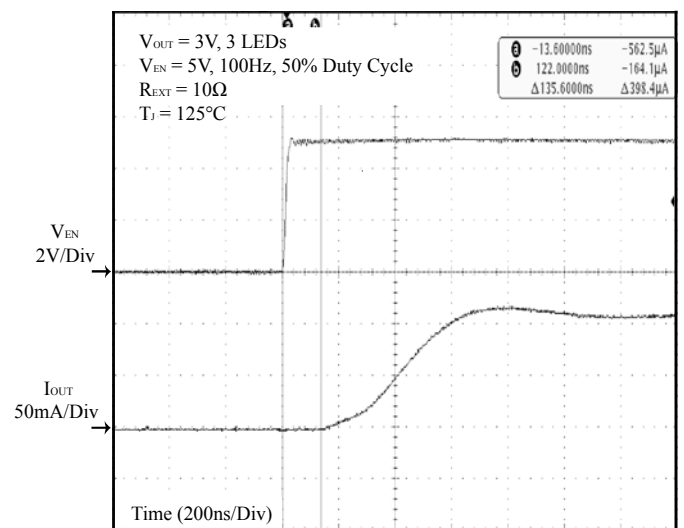

Figure 30 V_{EN} vs. I_{OUT} Delay and Rising Edge

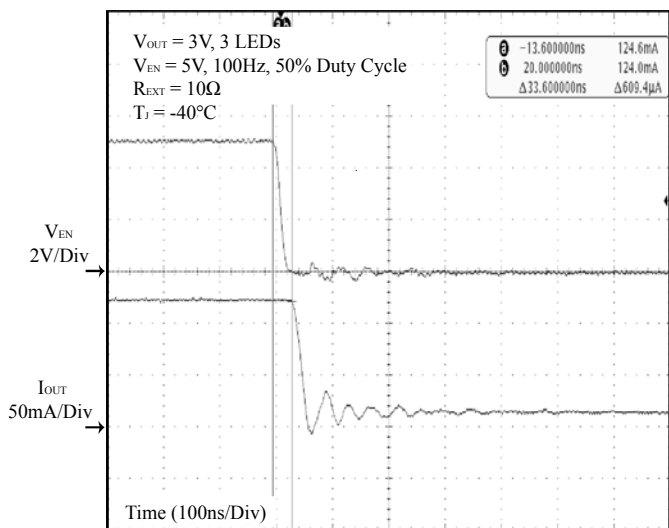

Figure 31 V_{EN} vs. I_{OUT} Delay and Falling Edge

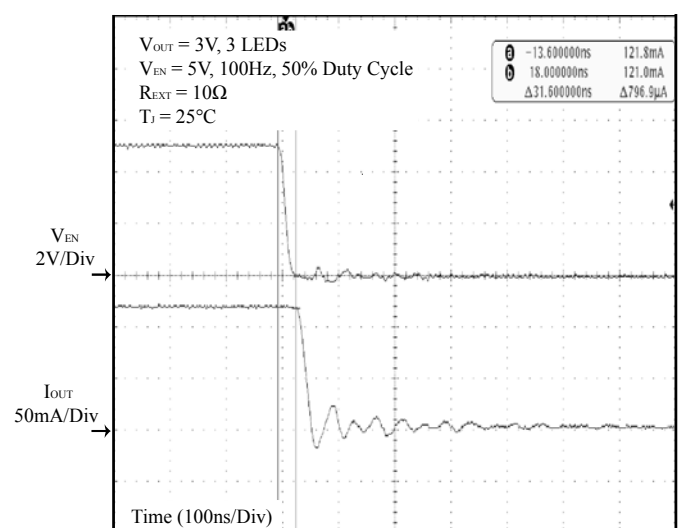

Figure 32 V_{EN} vs. I_{OUT} Delay and Falling Edge

IS31LT3170/71

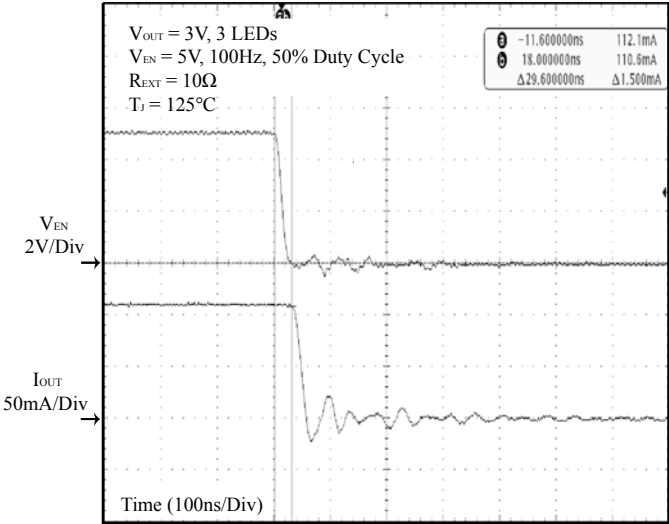

Figure 33 V_{EN} vs. I_{OUT} Delay and Falling Edge

IS31LT3170/71

APPLICATIONS INFORMATION

IS31LT3170/71 provides an easy constant current source solution for LED lighting applications. It uses an external resistor to adjust the LED current from 10mA to 150mA. The LED current can be determined by the Equation (1):

$$I_{SET} = 10mA \times \frac{(R_{INT} + R_{EXT})}{R_{EXT}} \quad (1)$$

Where R_{INT} (106Ω Typ.) is an internal resistor and R_{EXT} is the external resistor.

Paralleling a low tolerance resistor R_{EXT} with the internal resistor R_{INT} will improve the overall accuracy of the current sense resistance. The resulting output current will vary slightly lower due to the negative temperature coefficient (NTC) resulting from the self heating of the IS31LT3170/71.

HIGH INPUT VOLTAGE APPLICATION

When driving a long string of LEDs whose total forward voltage drop exceeds the IS31LT3170 V_{BD_OUT} limit of 42V, it is possible to stack several LEDs (such as 2 LEDs) between the EN pin and the OUT pins 2,3, and 5 so the voltage on the EN pin is higher than 5V. The remaining string of LEDs can then be placed between power supply $+V_S$ and EN pin, (Figure 34). The number of LEDs required to stack at EN pin will depend on the LED's forward voltage drop (V_F) and the $+V_S$ value.

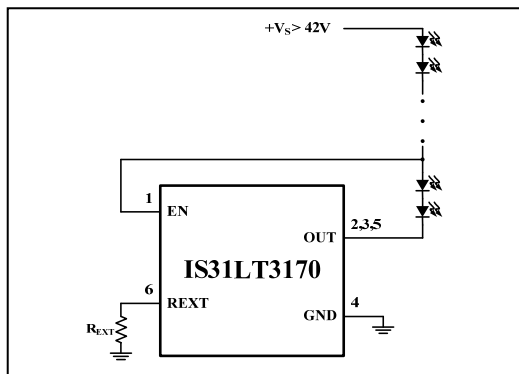

Figure 34 High Input Voltage Application Circuit

Note: when operating the IS31LT3170 at voltages exceeding the device operating limits, care needs to be taken to keep the EN pin and OUT pin voltage below 42V.

THERMAL PROTECTION AND DISSIPATION

The IS31LT3170/71 implements thermal foldback protection to reduce the LED current when the package's thermal dissipation is exceeded and prevent "thermal runaway". The thermal foldback implements a negative temperature coefficient (NTC) of -0.26%/K.

When operating the chip at high ambient temperatures, or when driving maximum load current, care must be taken to avoid exceeding the package power dissipation limits. Exceeding the package dissipation will cause the device to enter thermal protection mode. The maximum package power dissipation can be calculated using the following Equation (2):

$$P_{D(MAX)} = \frac{T_{J(MAX)} - T_A}{\theta_{JA}} \quad (2)$$

Where $T_{J(MAX)}$ is the maximum junction temperature, T_A is the ambient temperature, and θ_{JA} is the junction to ambient thermal resistance; a metric for the relative thermal performance of a package.

The recommended maximum operating junction temperature, $T_{J(MAX)}$, is 125°C and so the maximum ambient temperature is determined by the package parameter; θ_{JA} . The θ_{JA} for the IS31LT3170/71 SOT23-6 package, is 130°C/W.

Therefore the maximum power dissipation at $T_A = 25^\circ\text{C}$ is:

$$P_{D(MAX)} = \frac{125^\circ\text{C} - 25^\circ\text{C}}{130^\circ\text{C/W}} \approx 0.77\text{W}$$

The actual power dissipation P_D is:

$$P_D = V_{OUT} \times I_{OUT} + V_{EN} \times I_{EN} \quad (3)$$

To ensure the performance, the die temperature (T_J) of the IS31LT3170/71 should not exceed 125°C. The graph below gives details for the package power derating.

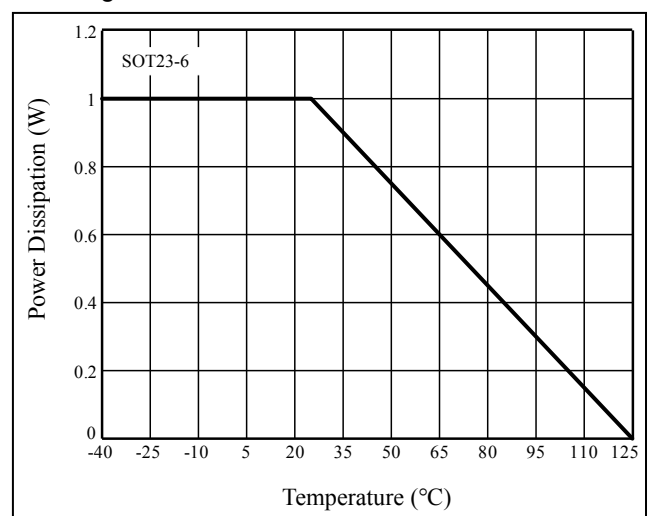

Figure 35 P_D vs. T_A (SOT23-6)

IS31LT3170/71

The thermal resistance is achieved by mounting the IS31LT3170/71 on a standard FR4 double-sided printed circuit board (PCB) with a copper area of a few square inches on each side of the board under the IS31LT3170/71. Multiple thermal vias, as shown in Figure 36, help to conduct the heat from the exposed pad of the IS31LT3170/71 to the copper on each side of the board. The thermal resistance can be reduced by using a metal substrate or by adding a heatsink.

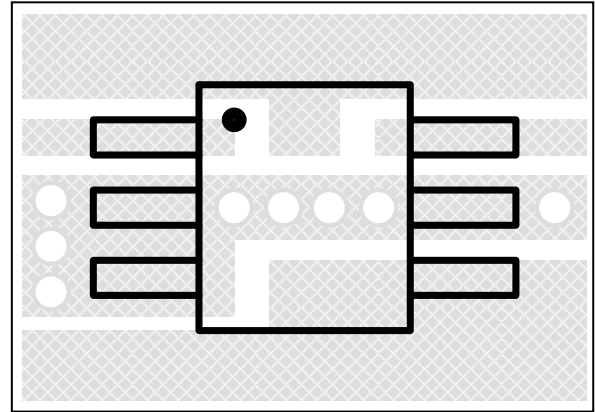

Figure 36 Board Via Layout For Thermal Dissipation

IS31LT3170/71

CLASSIFICATION REFLOW PROFILES

Profile Feature	Pb-Free Assembly
Preheat & Soak	150°C
Temperature min (T _{smin})	200°C
Temperature max (T _{smax})	60-120 seconds
Time (T _{smin} to T _{smax}) (t _s)	
Average ramp-up rate (T _{smax} to T _p)	3°C/second max.
Liquidous temperature (T _L)	217°C
Time at liquidous (t _L)	60-150 seconds
Peak package body temperature (T _p)*	Max 260°C
Time (t _p)** within 5°C of the specified classification temperature (T _c)	Max 30 seconds
Average ramp-down rate (T _p to T _{smax})	6°C/second max.
Time 25°C to peak temperature	8 minutes max.

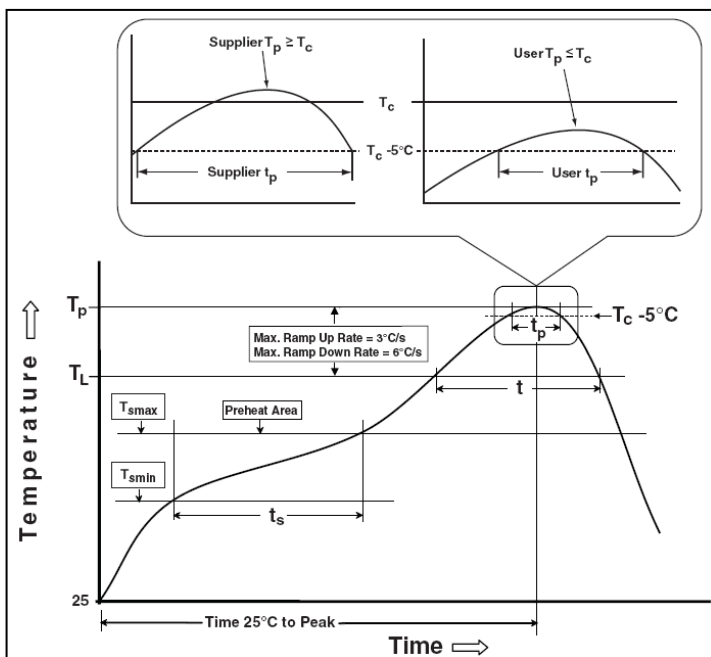
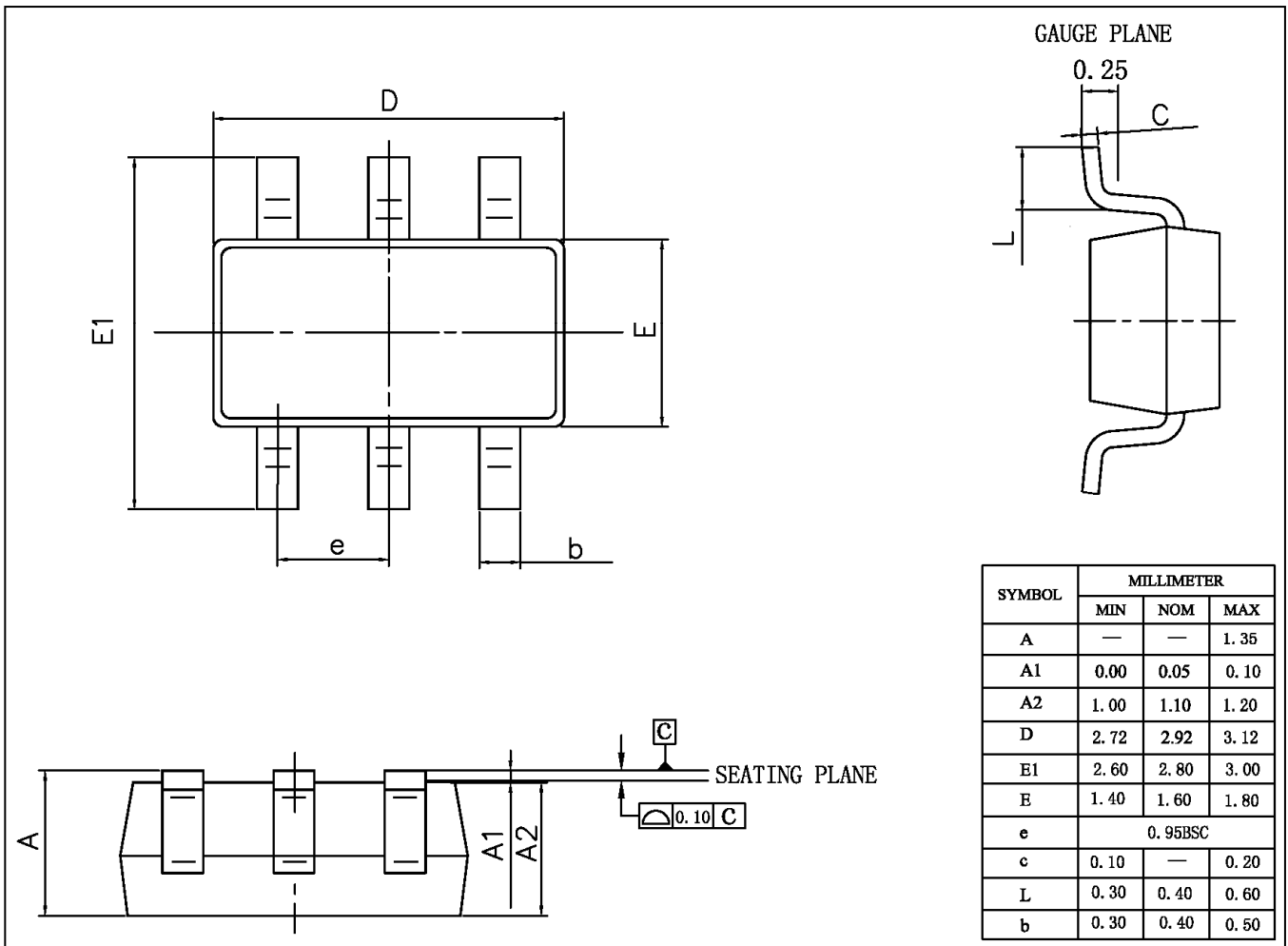

Figure 37 Classification Profile

IS31LT3170/71

PACKAGE INFORMATION

SOT23-6



IS31LT3170/71

RECOMMENDED LAND PATTERN

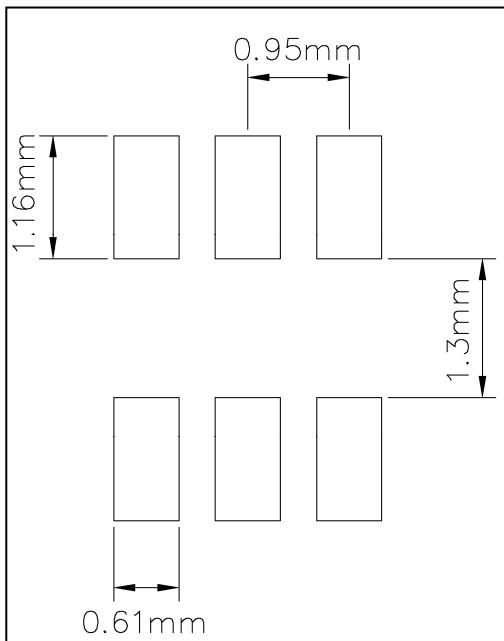

Note:

1. Land pattern complies to IPC-7351.
2. All dimensions in MM.
3. This document (including dimensions, notes & specs) is a recommendation based on typical circuit board manufacturing parameters. Since land pattern design depends on many factors unknown (eg. user's board manufacturing specs), user must determine suitability for use.



IS31LT3170/71

REVISION HISTORY

Revision	Detail Information	Date
A	Initial release	2016.05.04
B	Update EC table (output current limit)	2016.07.05
C	Update θ_{JA} value	2017.10.20